

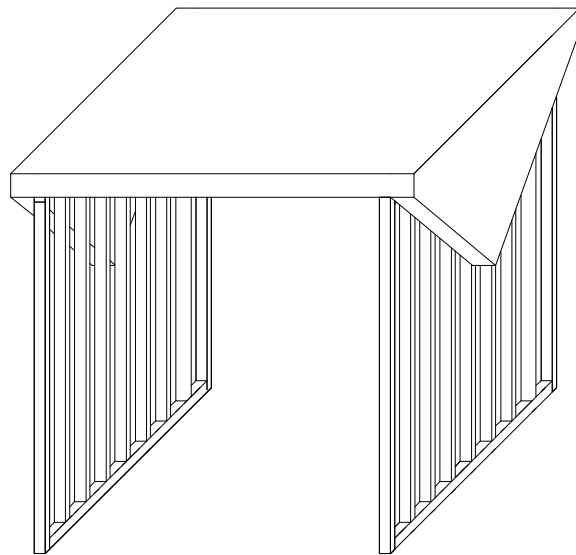

**SANDRA CORNER TABLE**  
ASSEMBLY INSTRUCTIONS  
**18136**





PLEASE READ ME FIRST



- Have questions about assembling your item?



- Item or parts damaged?



- Missing a part?



- We're here to help!



(847)949-6300 (M-F, 9am-5pm CST)



[www.burnhamhomedesign.com](http://www.burnhamhomedesign.com)



[customerservice@burnhamhomedesign.com](mailto:customerservice@burnhamhomedesign.com)

E

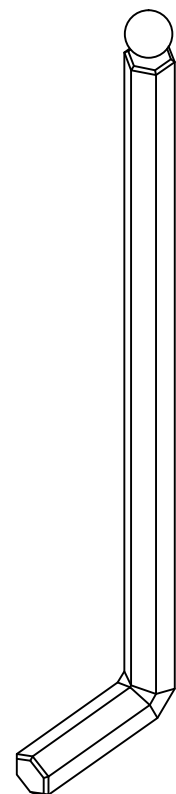

D



C

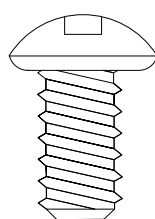

B

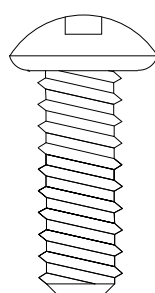

A

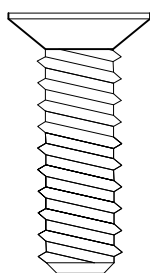

**M6x20mm**  
**2 PCS**

**M6x20mm**  
**3 PCS**

**M6x12mm**  
**12 PCS**

**15 PCS**

**1 PC**

①

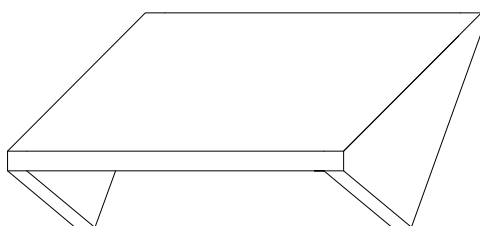

②

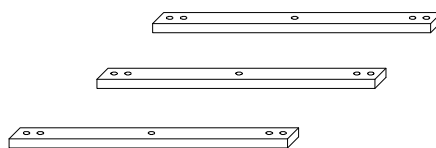

③

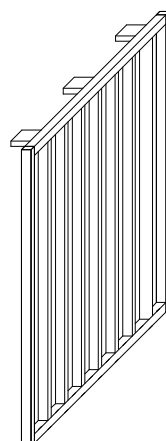
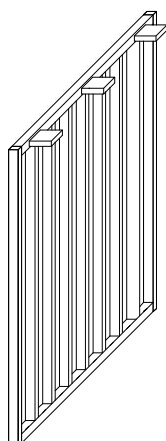

# 01

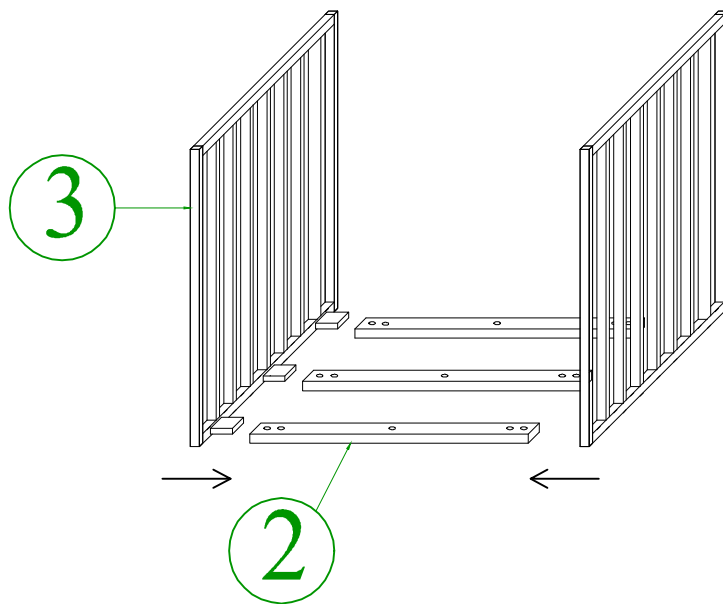



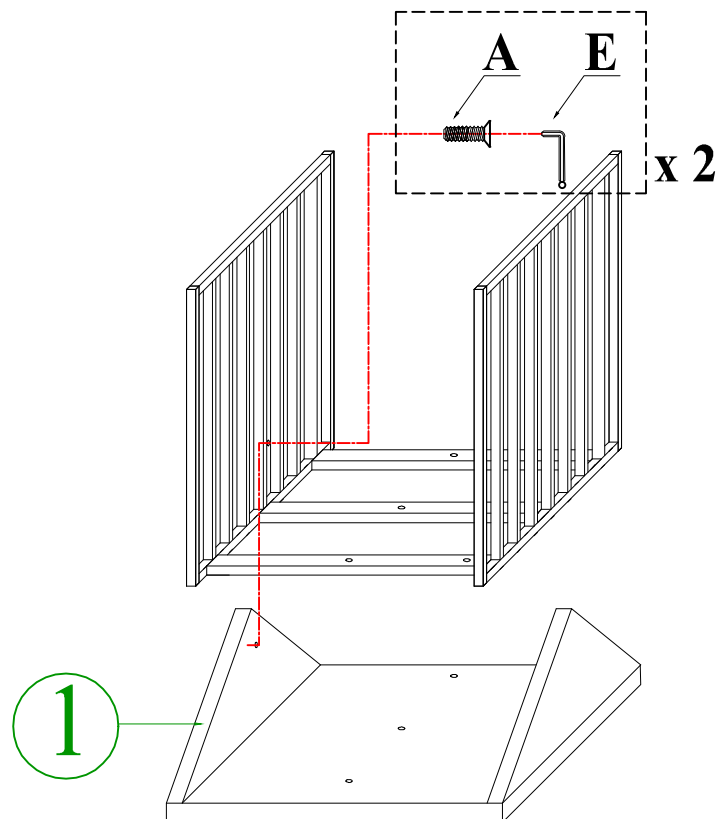
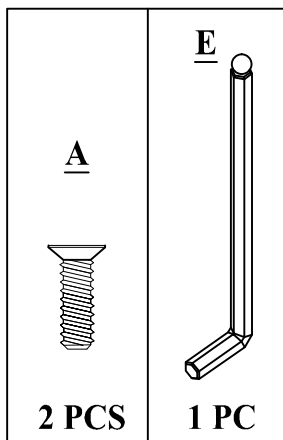

TIGHTEN BOLT COMPLETELY.

# 02

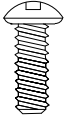

TIGHTEN BOLT COMPLETELY.

# 03

<b>B</b>  3 PCS	<b>C</b>  12 PCS	<b>D</b>  15 PCS	<b>E</b>  1 PC
--	---	---	---

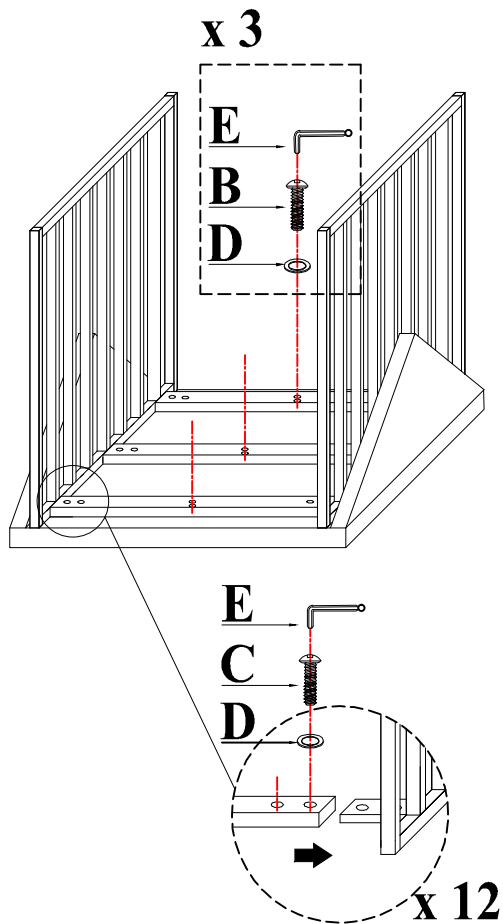

TIGHTEN BOLT COMPLETELY.

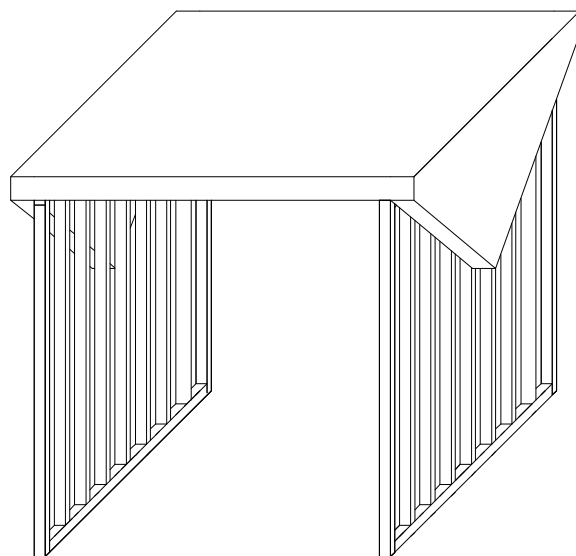

BE SURE TO CHECK ALL BOLTS ARE SECURELY  
TIGHTENED PRIOR USING THIS TABLE.