



SANDRA COFFEE TABLE

ASSEMBLY INSTRUCTIONS

18137





PLEASE READ ME FIRST



- Have questions about assembling your item?



- Item or parts damaged?



- Missing a part?



- We're here to help!



(847)949-6300 (M-F, 9am-5pm CST)



www.burnhamhomedesign.com



customerservice@burnhamhomedesign.com

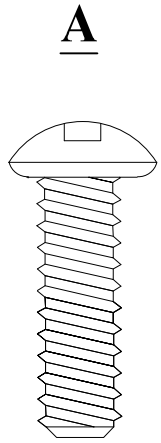

M6x25mm
4 PCS

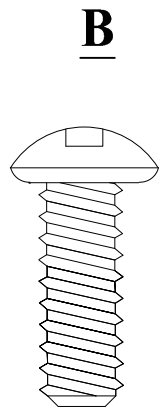

M6x20mm
4 PCS

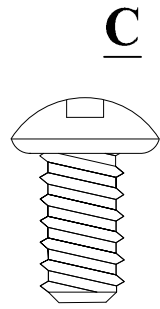

M6x12mm
8 PCS

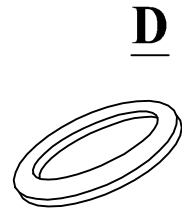

16 PCS

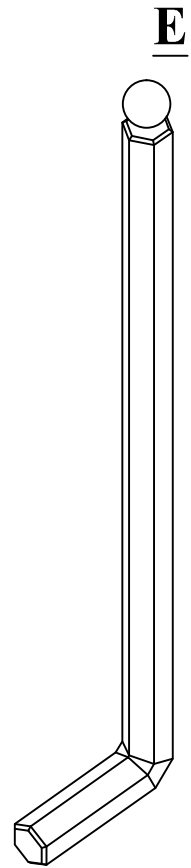

1 PC

①

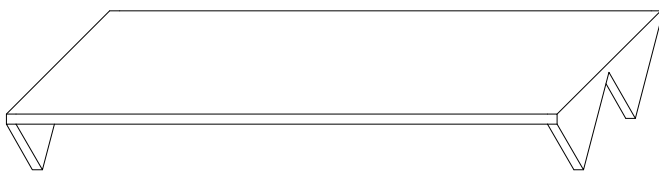

②

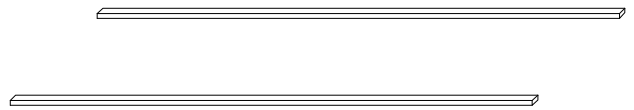

③

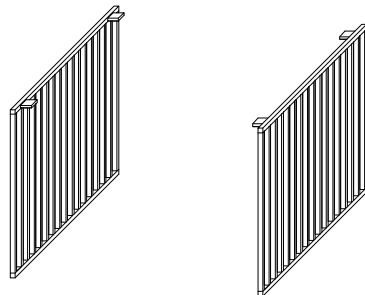

01

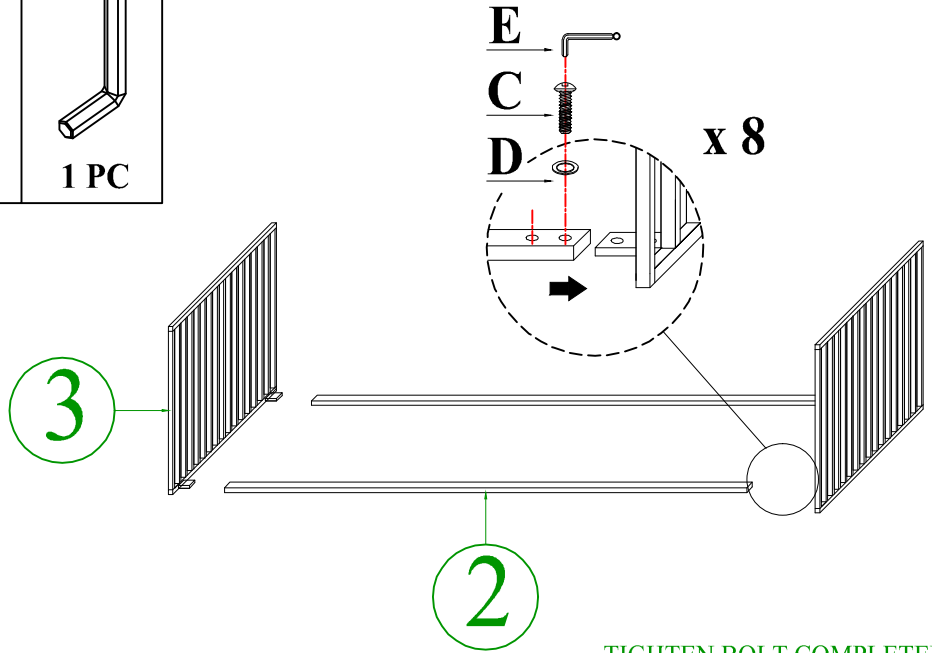
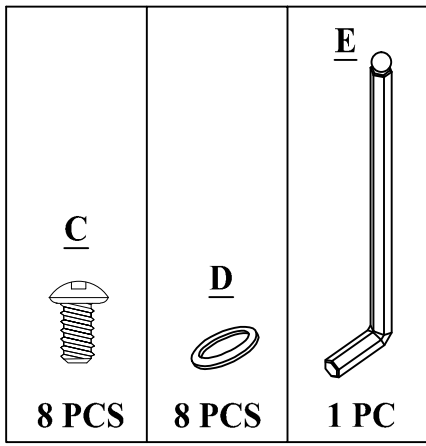

TIGHTEN BOLT COMPLETELY.

02

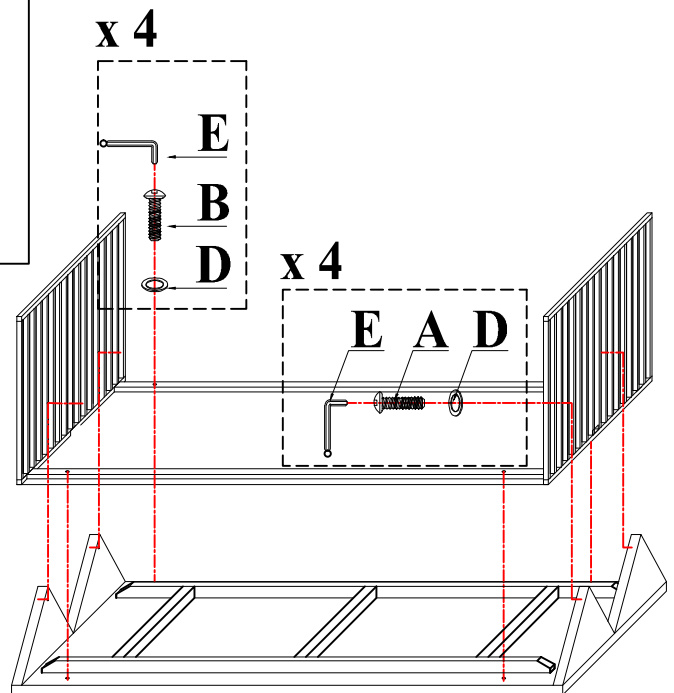
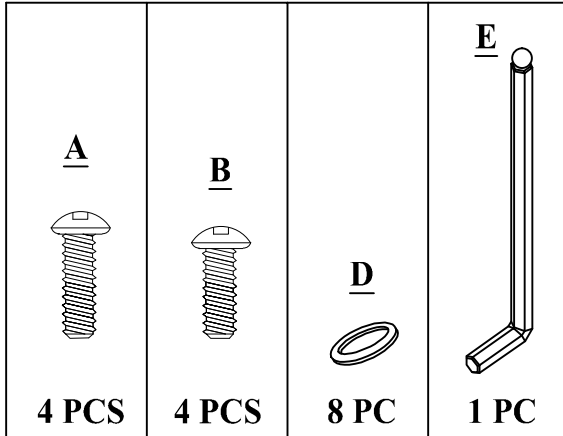

TIGHTEN BOLT COMPLETELY.

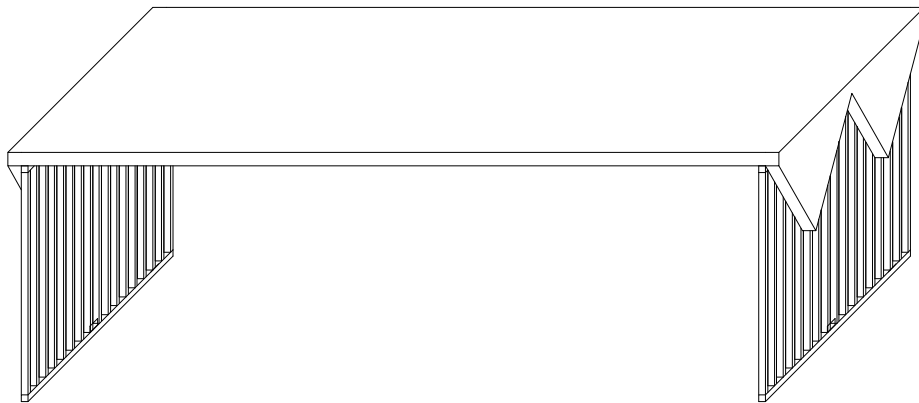

BE SURE TO CHECK ALL BOLTS ARE SECURELY
TIGHTENED PRIOR USING THIS TABLE.