

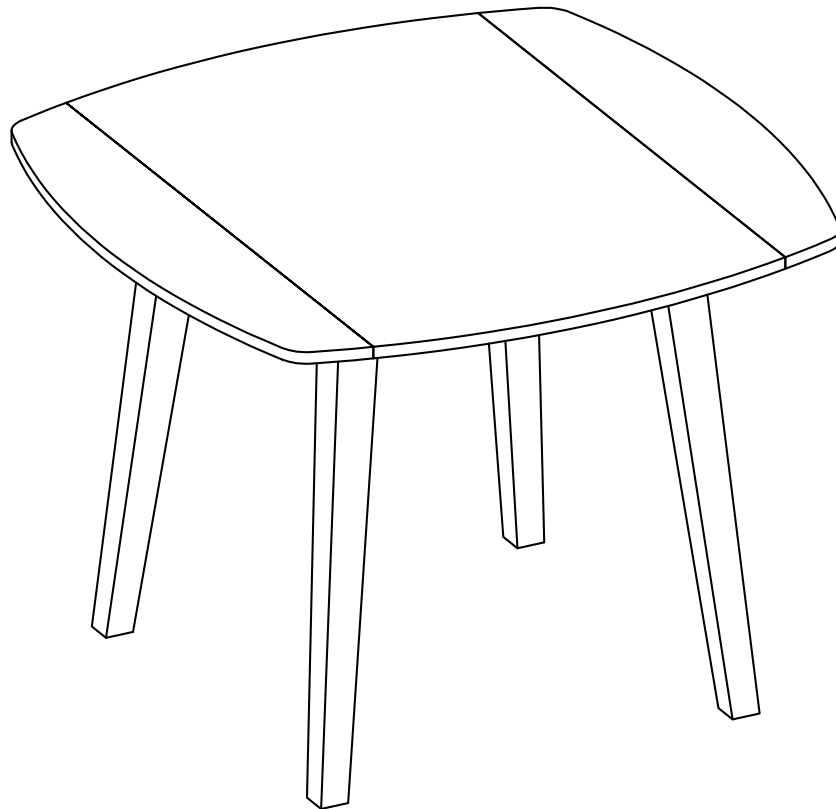

# Boraam Industries

ASSEMBLY INSTRUCTIONS

**SKU: 71036 | BOULDER TABLE**



Have questions about assembling your item?



Items or parts damaged?



Missing a part?

**We're here to help! (Monday-Friday from 9am-5pm CST)**



847-949-6300  
877-267-2261



customerservice@  
boraamindustries.com



www.boraamindustries.com

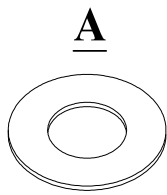

**Flat Washer**  
**8 PCS**



**Spring Washer**  
**8 PCS**

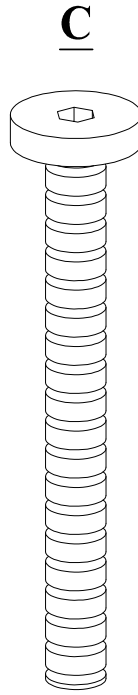

**M8\*70**  
**8 PCS**

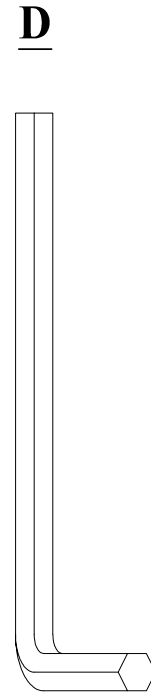

**Allen Wrench**  
**1 PC**

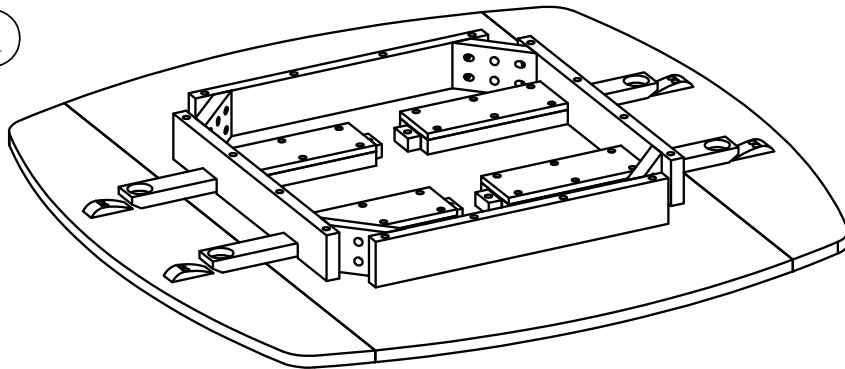

**1**

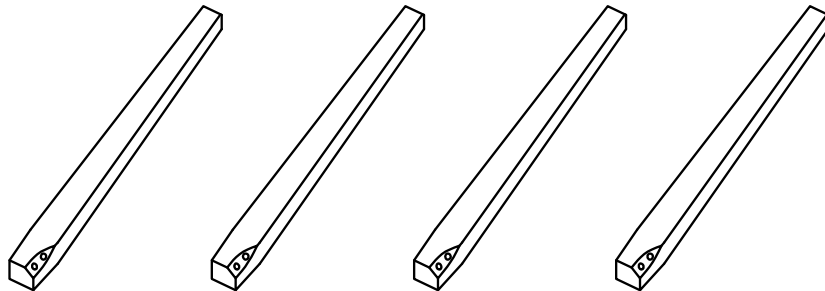

**2**

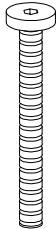

# 01

<b>A</b>  8 PCS	<b>B</b>  8 PCS	<b>C</b>  M8*70 8 PCS
--	--	---

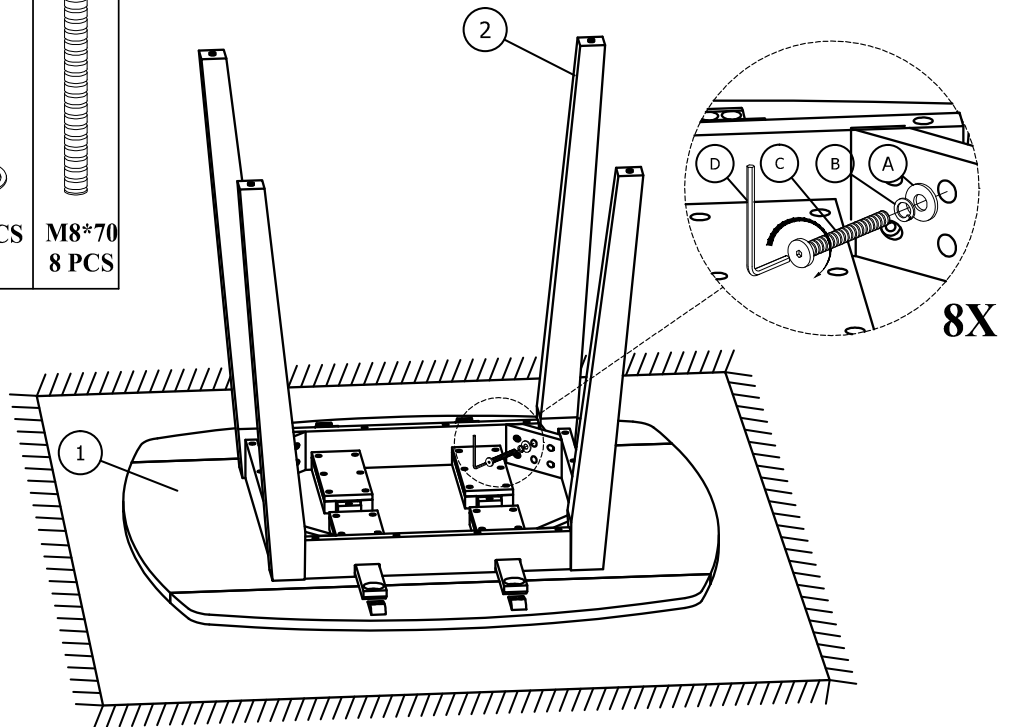

TIGHTEN BOLT COMPLETELY.

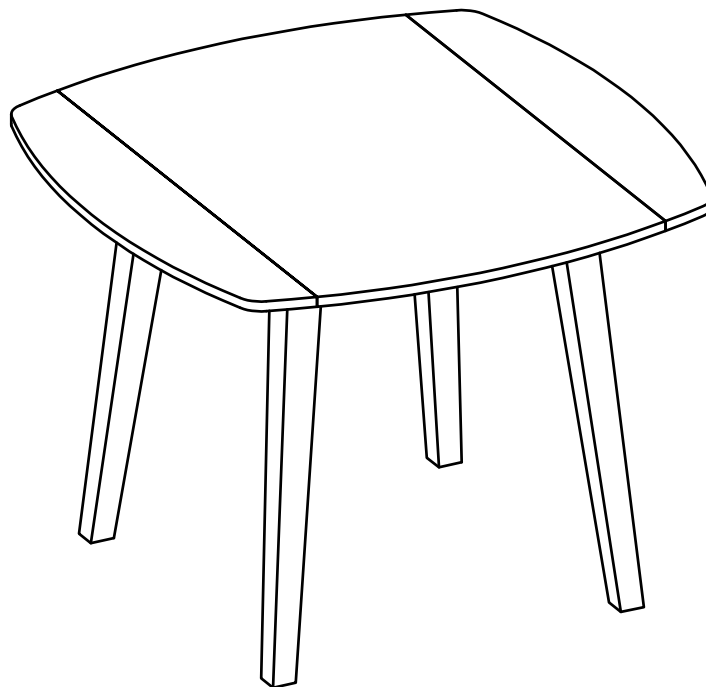

BE SURE TO CHECK ALL BOLTS ARE SECURELY TIGHTENED PRIOR USING THIS TABLE

847-949-6300 | 877-267-2261 | [customerservice@boraamindustries.com](mailto:customerservice@boraamindustries.com)



# Boraam Industries

ASSEMBLY INSTRUCTIONS

**SKU: 71026 | BOULDER DINING CHAIR**

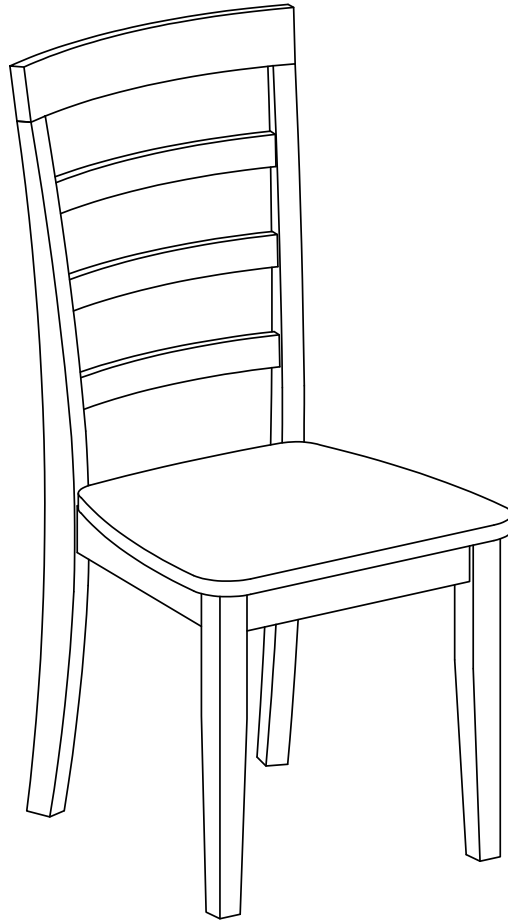

Have questions about assembling your item?



Items or parts damaged?



Missing a part?

**We're here to help! (Monday-Friday from 9am-5pm CST)**



847-949-6300  
877-267-2261



customerservice@  
boraamindustries.com



www.boraamindustries.com

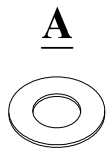

**Flat Washer**  
**11 PCS**



**Spring Washer**  
**11 PCS**

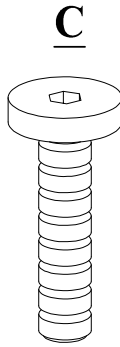

**M6\*40**  
**3 PCS**

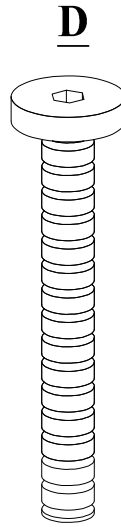

**M6\*60**  
**4 PCS**

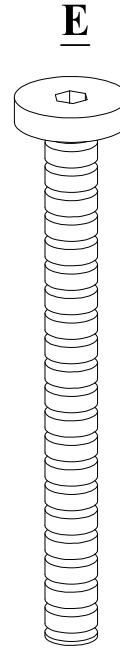

**M6\*80**  
**4 PCS**

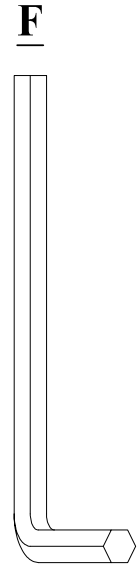

**Allen Wrench**  
**1 PC**

①

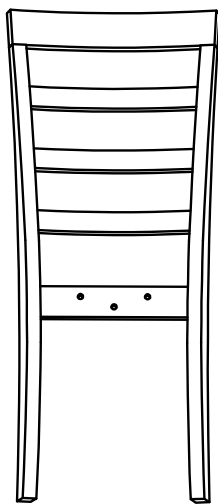

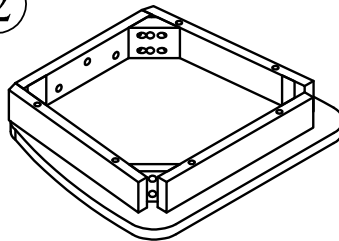

②

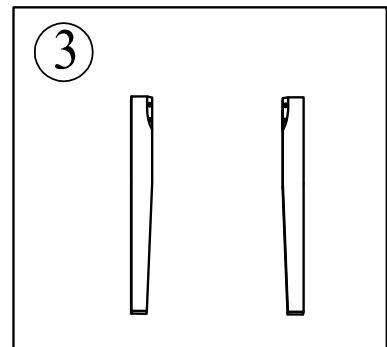

③



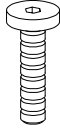
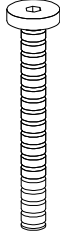

# 01

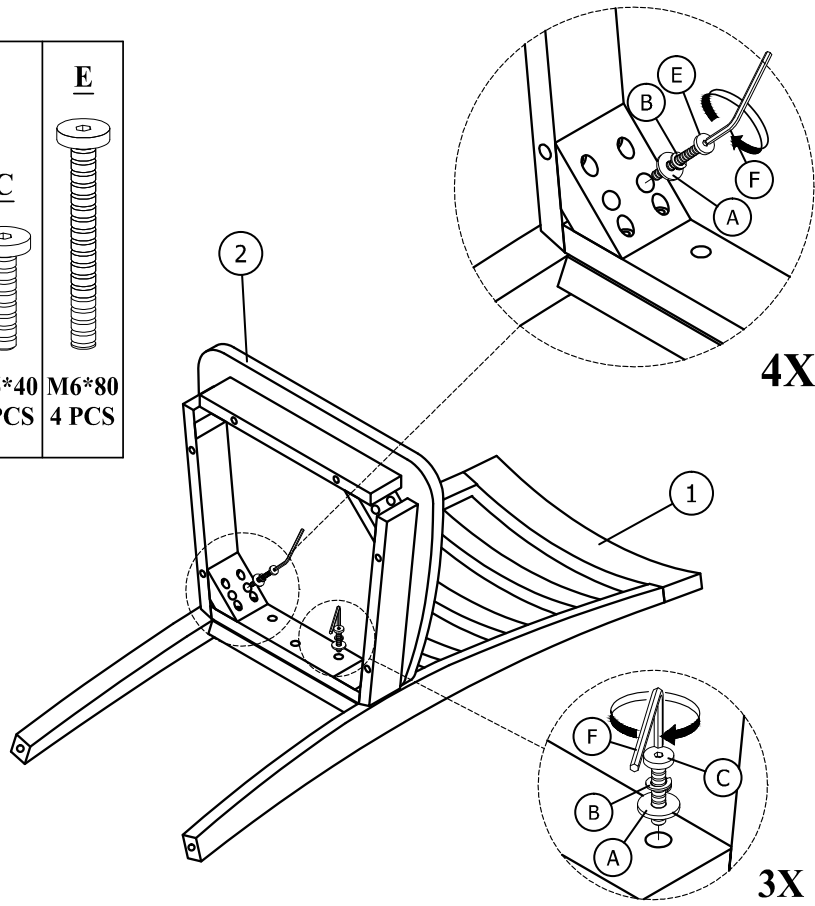
<b>A</b>	<b>B</b>	<b>C</b>	<b>E</b>
			
7 PCS	7 PCS	M6*40 3 PCS	M6*80 4 PCS



TIGHTEN BOLT COMPLETELY.

# 02

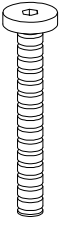
<b>A</b>	<b>B</b>	<b>D</b>
		
4 PCS	4 PCS	M6*60 4 PCS

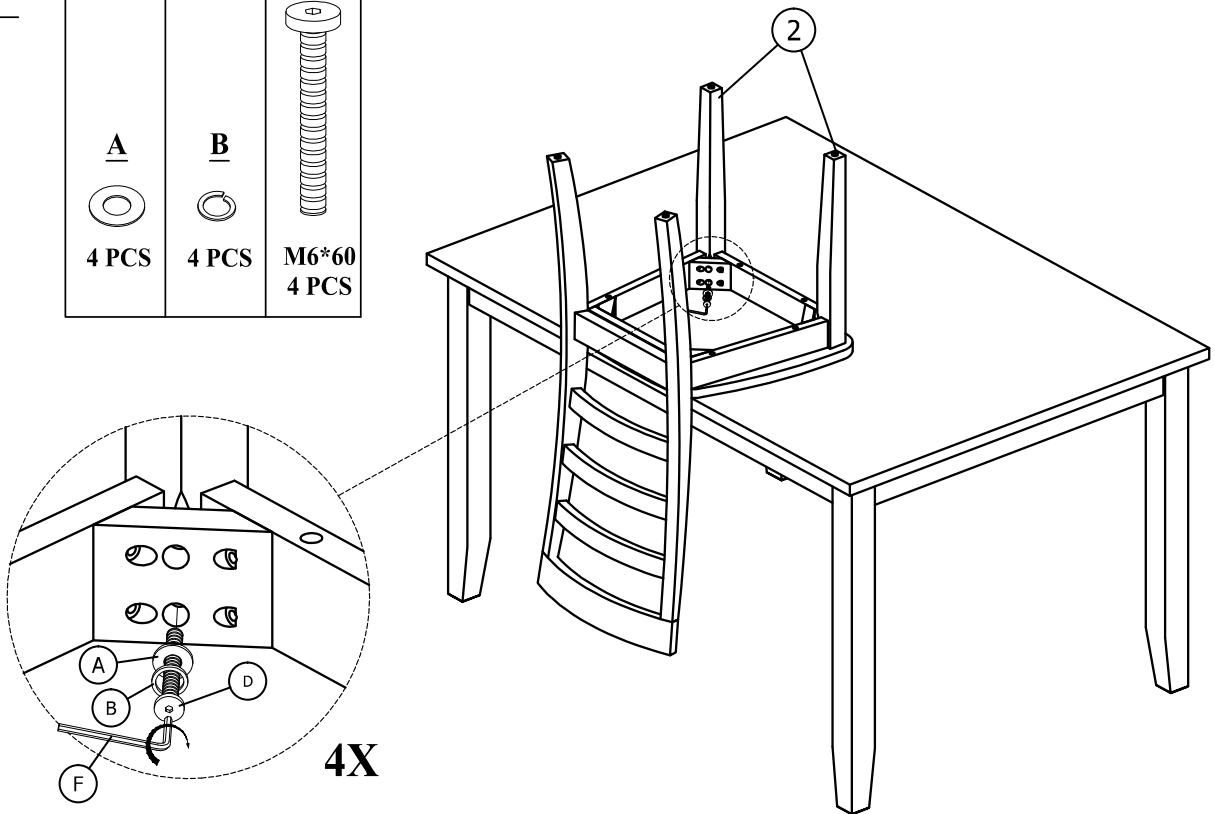

TIGHTEN BOLT COMPLETELY.

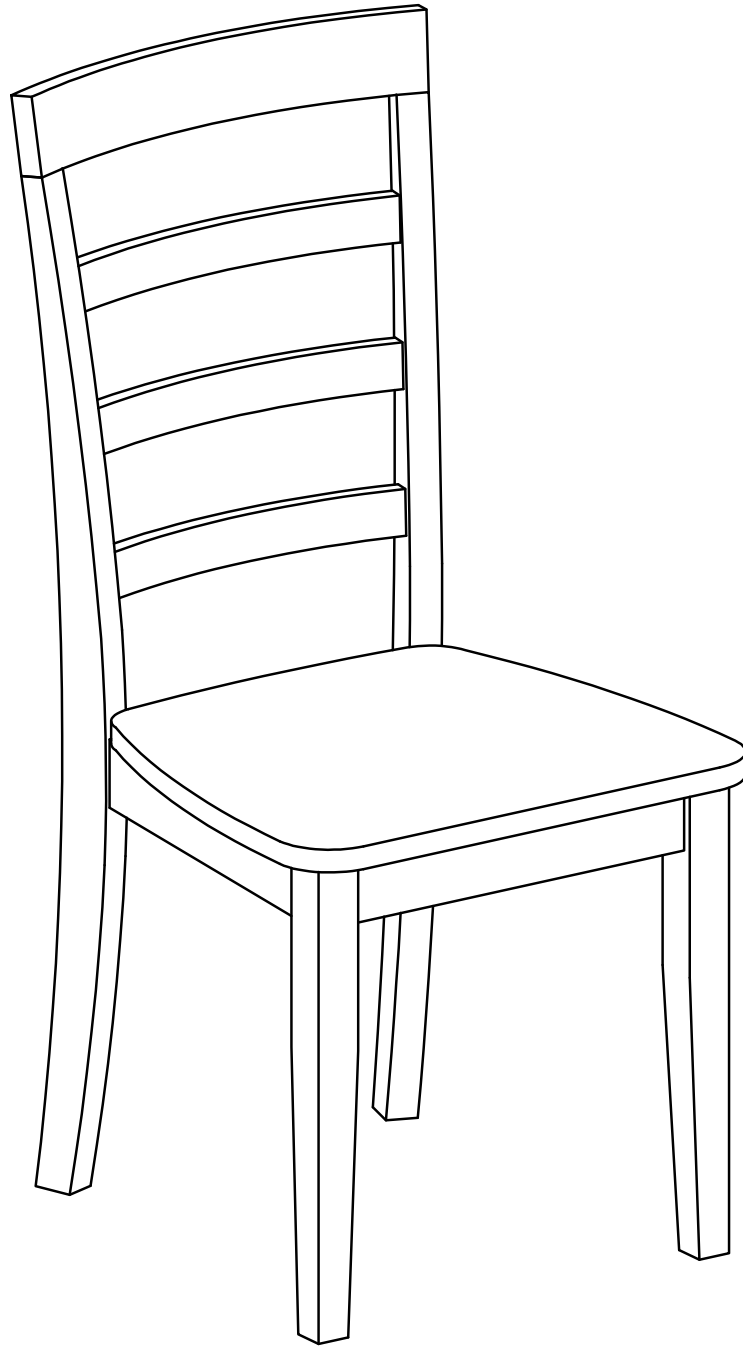

BE SURE TO CHECK ALL BOLTS ARE SECURELY TIGHTENED PRIOR USING THIS CHAIR

847-949-6300 | 877-267-2261 | [customerservice@boraamindustries.com](mailto:customerservice@boraamindustries.com)